



36 CF II Fireplace

- Operation
- Maintenance



Tested and Listed by
OMNI-Test Laboratories, Inc.
Beaverton, Oregon
Report # 028-S-57-5
ANSI Z21.88b-2003

WARNING: If the information in these instructions is not followed exactly, a fire or explosion may result causing property damage, personal injury or loss of life.

- Do not store or use gasoline or other flammable vapors and liquids in the vicinity of this or any other appliance.

WHAT TO DO IF YOU SMELL GAS

- Do not try to light any appliance.
- Do not touch any electrical switch; do not use any phone in your building.
- Immediately call gas supplier from a neighbor's phone. Follow the gas supplier's instructions.
- If you cannot reach your gas supplier, call the fire department.
- Installation and service must be performed by a qualified installer, service agency or the gas supplier.

This appliance may be installed in an aftermarket permanently located, manufactured home (USA only) or mobile home, where not prohibited by local codes.

This appliance is only for use with the type(s) of gas indicated on the rating plate. A conversion kit is supplied with the appliance.

Owner's Manual



TRAVIS INDUSTRIES
HOUSE OF FIRE

Introduction

We welcome you as a new owner of a 36 CF II gas fireplace. This manual details operation and maintenance of this fireplace. Please familiarize yourself with the Owner's Manual before operating your heater and save the manual for future reference.

Important Information

No other 36 CF II gas fireplace has the same serial number as yours. The serial number is on the listing label that is chained to the gas control valve. This serial number may be needed in case you require service.

Model: 36 CF II Fireplace

Serial Number: _____

Purchase Date: _____

Purchased From: _____

Register your warranty online at:

traviswarranty.com

Or, mail your warranty card to:

Travis Industries House of Fire
4800 Harbour Pointe Blvd. SW
Mukilteo, WA 98275

Save Your Bill of Sale.

To receive full warranty coverage, you will need to show evidence of the date you purchased your heater. Do not mail your Bill of Sale to us.

We suggest that you attach your Bill of Sale to this page so that you will have all the information you need in one place should the need for service or information occur.

Installation Warnings

- **Installation requirements are printed in the 36 CF II Installation Manual (part # 100-01197). All requirements in the installation manual must be met.**
- **Failure to follow all of the requirements may result in property damage, bodily injury, or even death.**
- **This heater must be installed by a qualified installer who has gone through a training program for the installation of direct vent gas appliances.**
- **This appliance must be installed in accordance with all local codes, if any; if not, follow ANSI Z223.1 and NFPA 54(88).**
- **In Manufactured or Mobile Homes must conform with Manufactured Home Construction and Safety Standard, Title 24 CFR, Part 3280, or, when such a standard is not applicable, the Standard for Manufactured Home Installations, ANSI/NCSBCS A225.1. This appliance may be installed in Manufactured Housing only after the home is site located.**
- **The fireplace is designed to operate on natural gas, or propane (LP).**
- **All exhaust gases must be vented outside the structure of the living-area. Combustion air is drawn from outside the living-area structure.**
- **Notify your insurance company before hooking up this fireplace.**
- **The ceramic firebacks must be installed in this fireplace prior to operation.**

Table of Contents

Introduction and Important Information

Introduction 2
 Important Information 2
 Installation Warnings 2
 Features 3
 Gas Input Specifications 3

Safety Precautions

Safety Precautions 4

Operation

Before You Begin 6
 Controls 6
 Starting the Fireplace for the First Time 8
 Adjusting the Flame Height 8

Maintenance

Yearly Service Procedure 9
 Glass Frame Removal and Installation 10
 Log Set Installation 11
 Wiring Diagram 17
 Replacement Parts List 17

Warranty

Warranty 18

Optional Equipment

Optional Equipment List 19

Index

Index 20

Features

- Works During Power Outages
- Standard Remote Control with Thermostat
- Realistic "Wood Fire" Look
- Convenient Operating Controls
- Variable-Rate Heat Output
- Low Maintenance

Gas Input Specifications

	Natural Gas	Propane
Maximum BTU Input Per Hour	50,000	49,000
Minimum BTU Input on Low	28,500	26,900

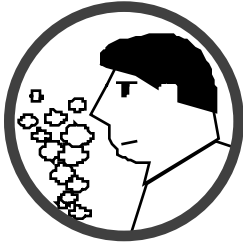
**IF YOU SMELL GAS:**

- * Do not light any appliance
- * Extinguish any open flame
- * Do not touch any electrical switch or plug or unplug anything
- * Open windows and vacate building
- * Call gas supplier from neighbor's house, if not reached, call fire department



This unit must be installed by a qualified installer to prevent the possibility of an explosion. Your dealer will know the requirements in your area and can inform you of those people considered qualified. The room heater should be inspected and cleaned before use and at least annually by a qualified service person. More frequent cleaning may be required due to excessive lint from carpeting, bedding material, etc.

The instructions in this manual must be strictly adhered to. Do not use makeshift methods or compromise in the installation. Improper installation will void the warranty and safety listing.

This heater is either approved for natural gas (NG) or for propane (LP). Burning the incorrect fuel will void the warranty and safety listing and may cause an extreme safety hazard. Direct questions about the type of fuel used to your dealer or installer

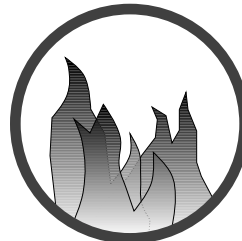
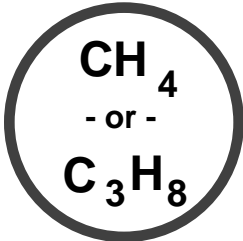

Operate the heater according to the instructions included in this manual.

If the main burners do not start correctly turn the gas off to the fireplace and call your dealer for service.



Contact your local building officials to obtain a permit and information on any installation restrictions or inspection requirements in your area. Notify your insurance company of this heater as well.



If the flame becomes sooty, dark orange in color, or extremely tall, do not operate the heater. Call your dealer and arrange for proper servicing.



It is imperative that control compartments, screens, or circulating air passageways of the heater be kept clean and free of obstructions. These areas provide the air necessary for safe operation.



Do not operate the heater if it is not operating properly in any fashion or if you are uncertain. Call your dealer for a full explanation of your heater and what to expect.



Do not store or use gasoline or other flammable liquids in the vicinity of this heater.



Do not operate if any portion of the heater was submerged in water or if any corrosion occurs. Immediately call a qualified service technician to inspect the appliance and to replace any part of the control system and any gas control that has been under water.



Do not place clothing or other flammable items on or near the heater. Because this heater can be controlled by a thermostat there is a possibility of the heater turning on and igniting any items placed on or near it.

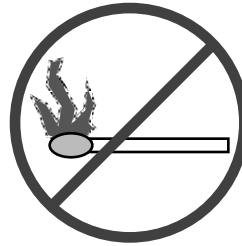

Light the heater using the built-in electronic igniter. Do not use matches or any other external device to light your heater.

Allow the heater to cool before carrying out any maintenance or cleaning.



The viewing glass should be opened only for conducting service. Do not operate with cracked, broken, or removed glass.

Any safety screen or guard removed for servicing must be replaced prior to operating the heater.

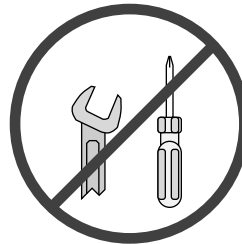

Never remove, replace, modify or substitute any part of the heater unless instructions are given in this manual. All other work must be done by a trained technician. Don't modify or replace orifices.

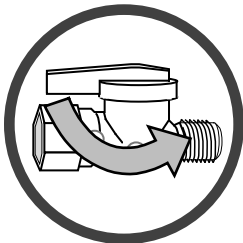

Prior to removing the glass, shut off gas to the appliance (or remove the batteries from the battery box and shut off electricity to the fireplace). This prevents any chance of accidental burner ignition when accessing the firebox.



Do not throw this manual away. This manual has important operating and maintenance instructions that you will need at a later time. Always follow the instructions in this manual.



This unit is not for use with solid fuel

Do not place anything inside the firebox (except the included fiber logs).

If the fiber logs become damaged, replace with Travis Industries log set.

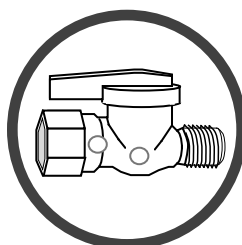

Instruct everyone in the house how to shut gas off to the appliance and at the gas main shutoff valve. The gas main shutoff valve is usually next to the gas meter or propane tank and requires a wrench to shut off.



Children and adults should be alerted to the hazards of high surface temperature and should stay away to avoid burns or clothing ignition. Young children should be supervised when they are in the same room as the heater.



Travis Industries, Inc. grants no warranty, implied or stated, for the installation or maintenance of your heater, and assumes no responsibility of any consequential damage(s).



Operate the heater according to the instructions included in this manual.

If the main burners do not start correctly turn the gas off to the fireplace and call your dealer for service.

Before You Begin

Read this entire manual before you use your new fireplace (especially the section "Safety Precautions" on pages 4 & 5). Failure to follow the instructions may result in property damage, bodily injury, or even death.

Controls

Remote Control

The remote control can turn the fireplace on and off or operate as a thermostat. In addition, it can turn the flame height up or down.

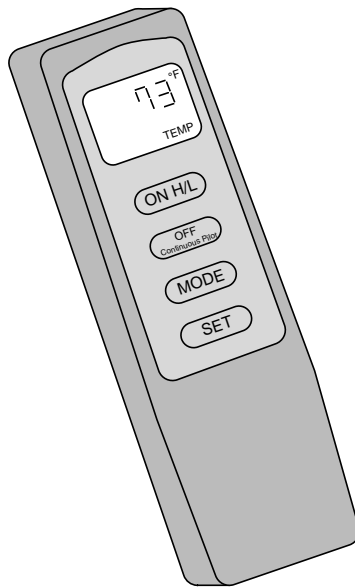

Wall Switch

The wall switch can turn the fireplace on and off or turn the flame height up or down.

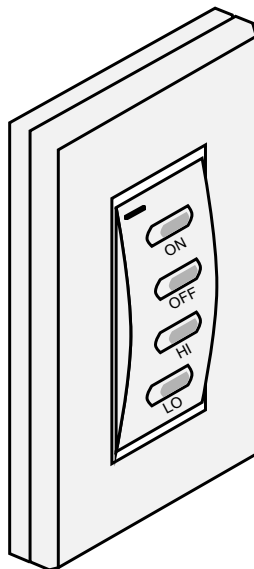

The Two Modes of Operation

This fireplace uses both a wall switch and thermostat to control the fireplace.

NOTE: Whichever component is operated last controls the fireplace. If you are using the remote and you press any button on the wall switch, the remote is no longer in control of the fireplace until a button is pressed on the remote.

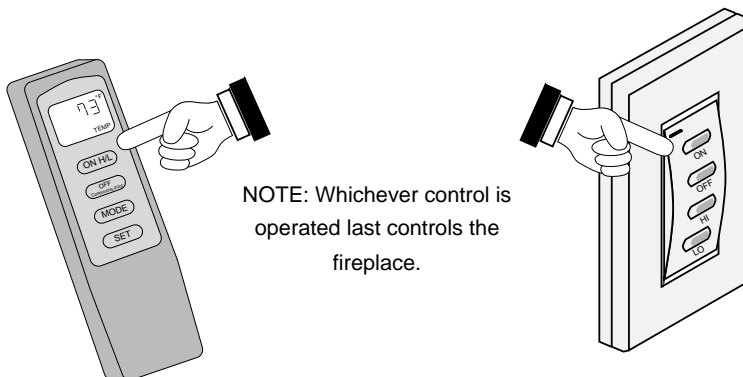

Manual Mode

In manual mode you can turn the fireplace on and off using either the thermostat or remote. Simply press the “ON” and “OFF” buttons on either the wall switch or remote.

Thermostat Mode

While in thermostat mode, the remote will monitor the temperature and turn the fireplace on and off to meet the desired temperature.

To turn on Thermostat Mode:

Press the “MODE” button on the remote until “ROOM” appears on the LCD display.

To turn off Thermostat Mode:

Press the “MODE” button on the remote until “ROOM” no longer appears on the LCD display.

When the remote is in thermostat mode the word "ROOM" will appear on the remote.

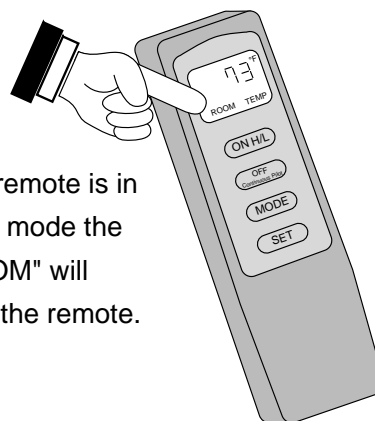

Adjusting the Target Temperature of the Thermostat:

Make sure the remote is in thermostat mode. Hold down the “SET” button until the desired temperature is displayed (“SET TEMP” will be displayed on the LCD, indicating that the thermostat temperature is being set). The thermostat may be set at any temperature between 45° and 99° F. If the desired temperature is missed, simply hold down the button (the temperature will scroll up to 99° then re-start at 45°).

NOTE: If the fireplace is in thermostat mode, and any button on the wall switch is pressed, the remote will return to manual mode. Simply press any button on the remote to return control of the fireplace to the remote.

WARNING: While in thermostat mode the fireplace will turn on and off to meet the temperature demands of the remote. Do not place any items near the fireplace or conduct service without removing the batteries and disabling the fireplace.

WARNING: If the remote is set to a high temperature the fireplace may remain on for an extended period of time. This may be a concern to those using LP (propane).

Starting the Fireplace for the First Time

- Burn the heater at a high setting for an extended period (up to 48 hours). This will cure the painted surfaces. **Fumes** from the paint curing and oil burning off the steel will occur. This is normal. We recommend opening a window to vent the room.
- **Condensation** may appear on the glass each time you start the fireplace - this is normal.
- **Blue Flames** will occur on the fireplace when it first comes on. After fifteen minutes the flames will turn a more realistic yellow and orange color.

Adjusting the Flame Height

Adjustment with the Wall Switch (recommended)

With the fireplace in manual mode and the fireplace on, click the “HI” or “LO” button until the desired flame height is achieved.

Adjustment with the Remote

With the fireplace in manual mode and the fireplace on, click and hold the “ON” button until the desired flame height is achieved. Each time the “ON” button is held down, the flame height will toggle between getting taller (“HI” will be displayed on the LCD screen) or getting smaller (“LO” will be displayed on the LCD screen).

Continuous Pilot – For Very Cold Conditions

This fireplace can be configured to run with an intermittent or continuous (standing) pilot. For normal conditions we recommend using the intermittent pilot (pilot is on only when the main burner is on). For extremely cold conditions we recommend using a continuous pilot (pilot is on all the time). By having the pilot on continuously, a draft is established in the vent, allowing the main burner to turn on with less air-flow disruption.

Setting the Fireplace to Continuous Pilot

Press and hold down the “OFF Continuous Pilot” button on the remote for 10 seconds. “PILOT” will appear on the LCD screen, indicating that the fireplace is configured for a continuous pilot. To configure the fireplace for an intermittent pilot, press and hold down the “OFF Continuous Pilot” button on the remote for 10 seconds until the “PILOT” is no longer visible on the LCD screen.

Child Protection Feature

The remote can be disabled to prevent children from operating the fireplace. This is done by holding down the “ON H/L” and “MODE” button for 5 seconds until “CP” (Child Protection) appears on the screen. If any button is pressed on the remote “CP” will appear on the screen indicating the child protection feature is on. To turn this feature off, hold down the “ON H/L” and “MODE” button for 5 seconds until “CP” disappears from the screen.

Heat Bypass

This fireplace is equipped with a heat bypass to adjust the amount of heat entering the room. The bypass is located directly above the glass frame in the center of the fireplace.

Setting the Bypass to the Closed Position (more heat in the room)

Use a 1/4” nutdriver to turn the bypass clockwise.

Setting the Bypass to the Open Position (less heat in the room)

Use a 1/4” nutdriver to turn the bypass counter-clockwise.

Normal Operating Odors

This appliance has several areas that reach high temperatures. Dust or other particles on these areas may burn and create an odor. This is normal during start-up. You may notice the smell is more acute if the appliance was left idle for a long period.

Yearly Service Procedure

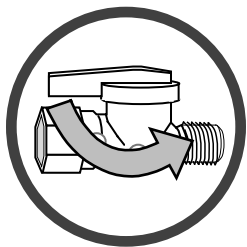

WARNING: Prior to removing the glass, shut off gas to the appliance (or remove the batteries from the battery box and shut off electricity to the fireplace). This prevents any chance of accidental burner ignition when accessing the firebox.

- Failure to inspect and maintain the fireplace may lead to improper combustion and a potentially dangerous situation. We recommend the following procedures be done by a qualified technician.
1. Remove the glass frame and log set (**NOTE: the logs are very fragile** - see page 11). If severely deteriorated, replace. Check the logs for sooting. A small amount of soot along the bottom of the logs is normal. If excessive sooting is found, the fireplace will require adjustment. Contact your dealer.
 2. Inspect the burner and remove any debris.
 - Make sure the burner is not warped, cracked, or damaged.
 - Check the firebox and area around the pilot to make sure there is no warping or damage.
 - If any problem is found, discontinue use and contact your dealer for service.

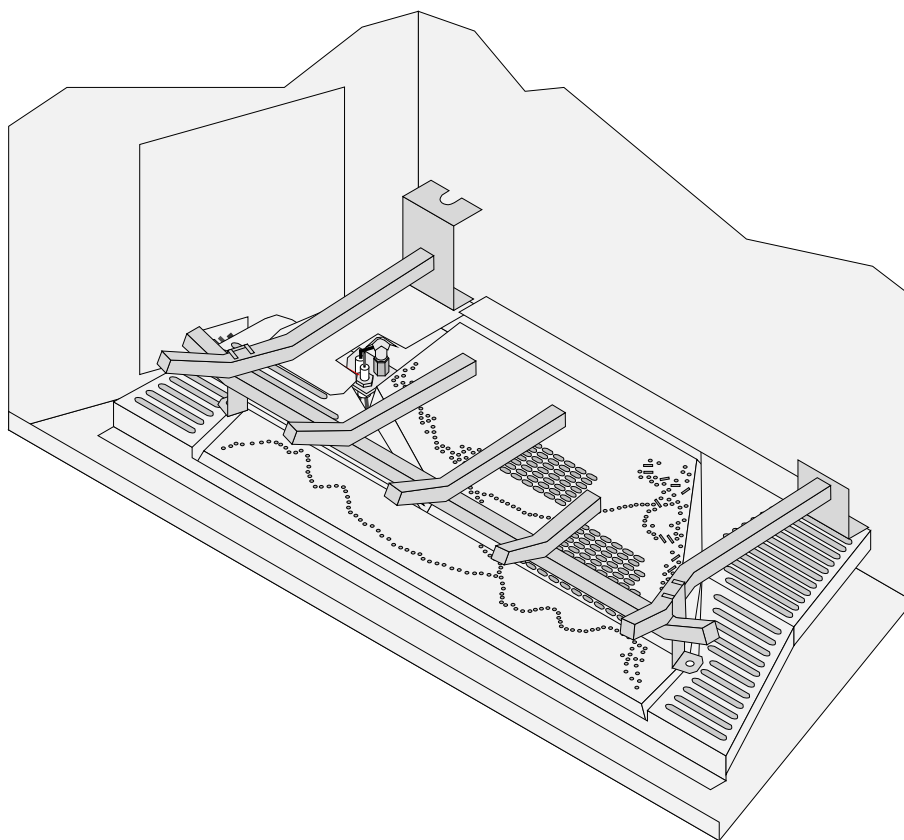

3. Replace the log set. Clean and replace the glass. If the glass is damaged, replace. Make sure the gasket along the perimeter of the glass contacts the face of the firebox and forms an air-tight seal. If it does not, re-align or replace the gasket to insure an air-tight seal.
4. Start the burner. The flames should be orange/yellow and not touch the top of the firebox. If the pilot or main burners do not burn correctly, contact your dealer for service.
5. Remove any debris or vegetation near the vent termination. Contact your dealer if any sooting or deterioration is found near the vent termination.

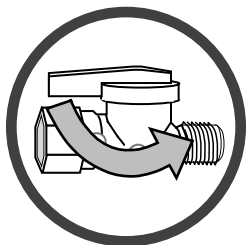
Glass Frame Removal and Installation

WARNING: Prior to removing the glass, shut off gas to the appliance (or remove the batteries from the battery box and shut off electricity to the fireplace). This prevents any chance of accidental burner ignition when accessing the firebox.

Warning: The appliance must be completely cool before removing the glass.

Warning: Do not strike or slam the glass.

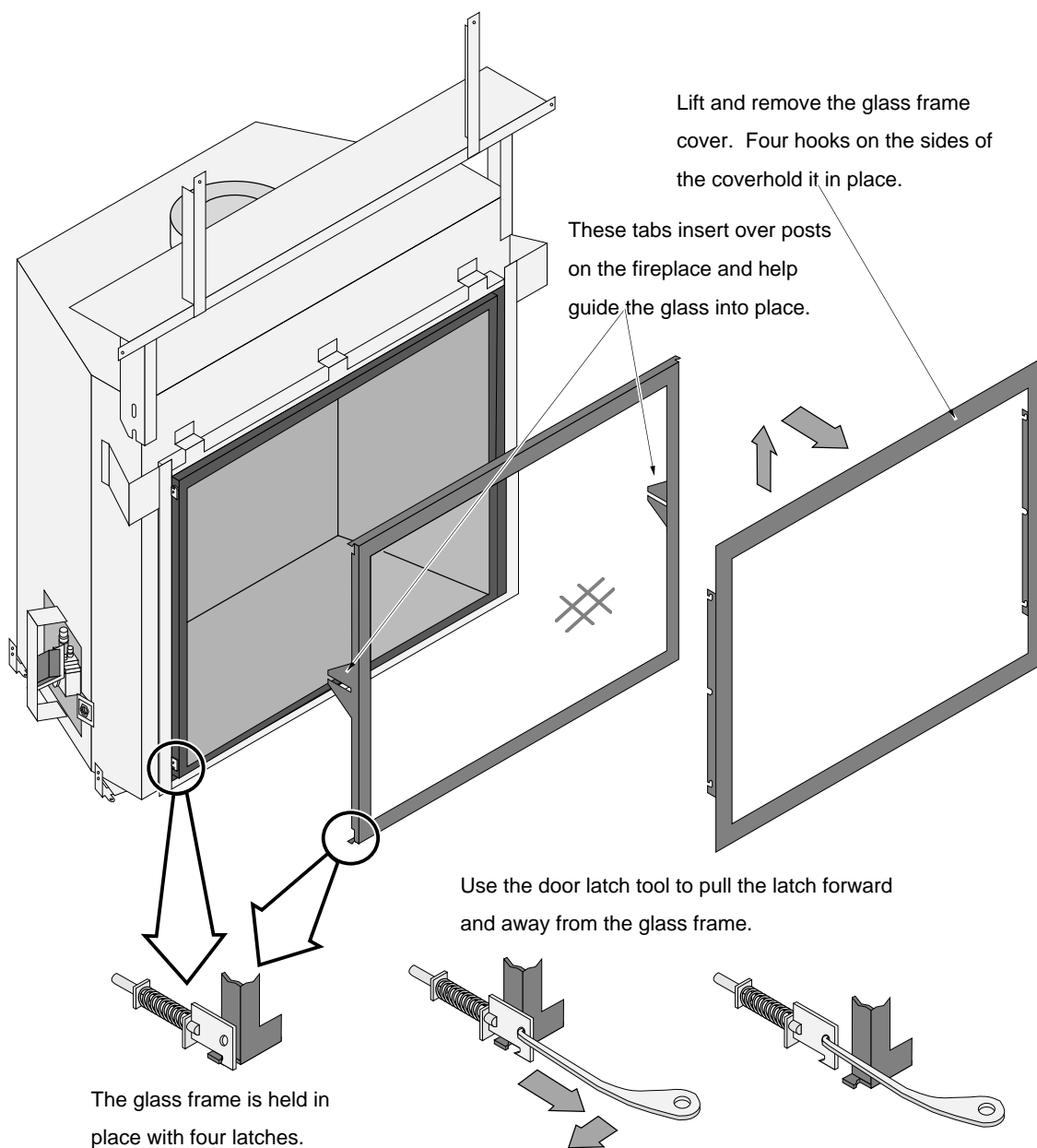
**REPLACING THE GLASS**

Slide the glass into place and secure the four latches.

Log Set Installation

Overview

Below is a picture detailing log placement for this fireplace. Follow the directions on the following pages to place the logs correctly.

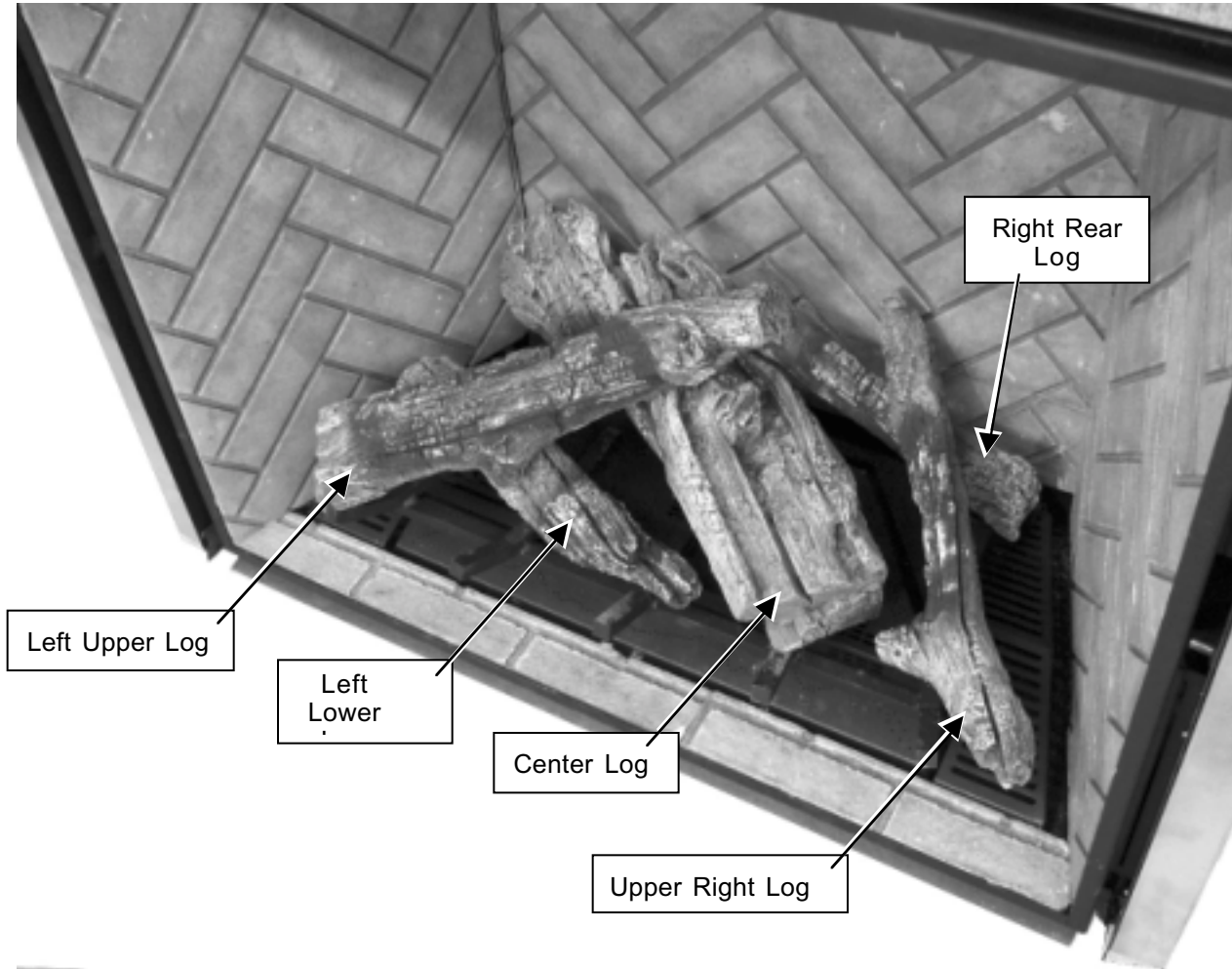

Center Log

Place the center log as shown below.

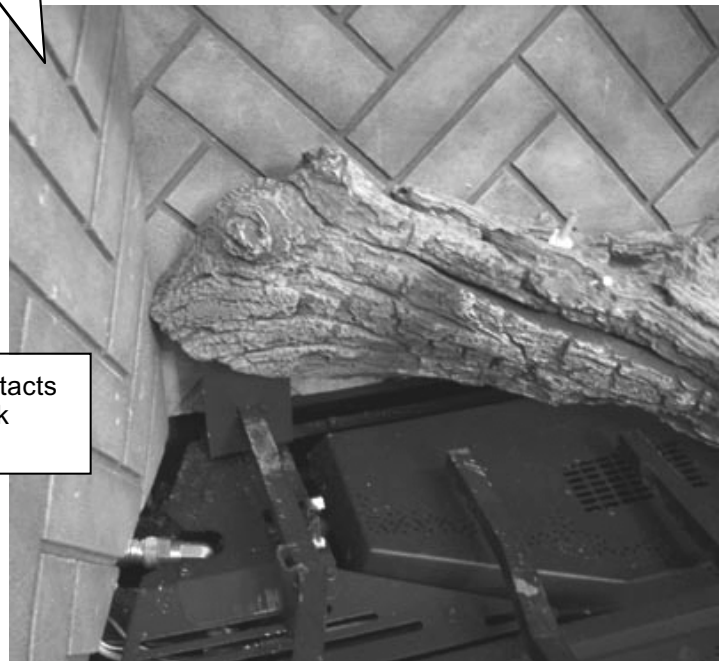

The rear log contacts
the side and back
fireback.

Left Lower Log

Place the left lower log as shown below.



Right Rear Log

Place the right rear log as shown below.

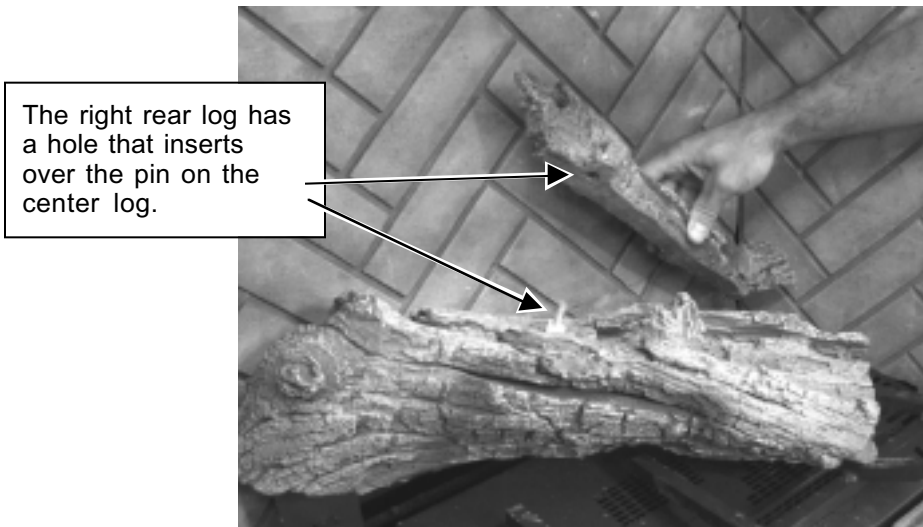

Upper Left Log

Place the upper left log as shown below.



The upper left log has a hole that inserts over the pin on the center log.

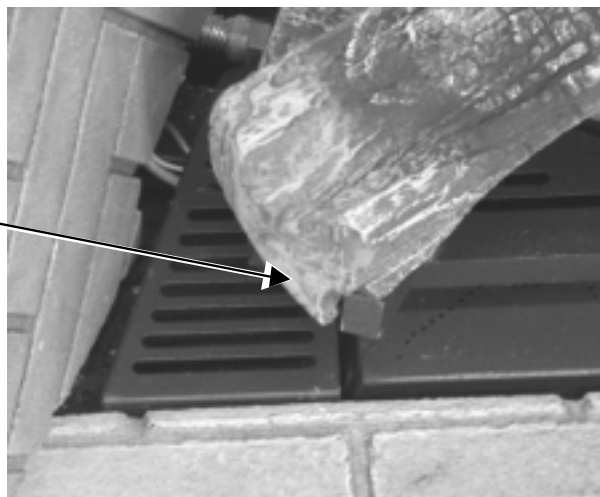

The upper left log has a notch that fits over the grate.

Upper Right Log

Place the upper right log as shown below.

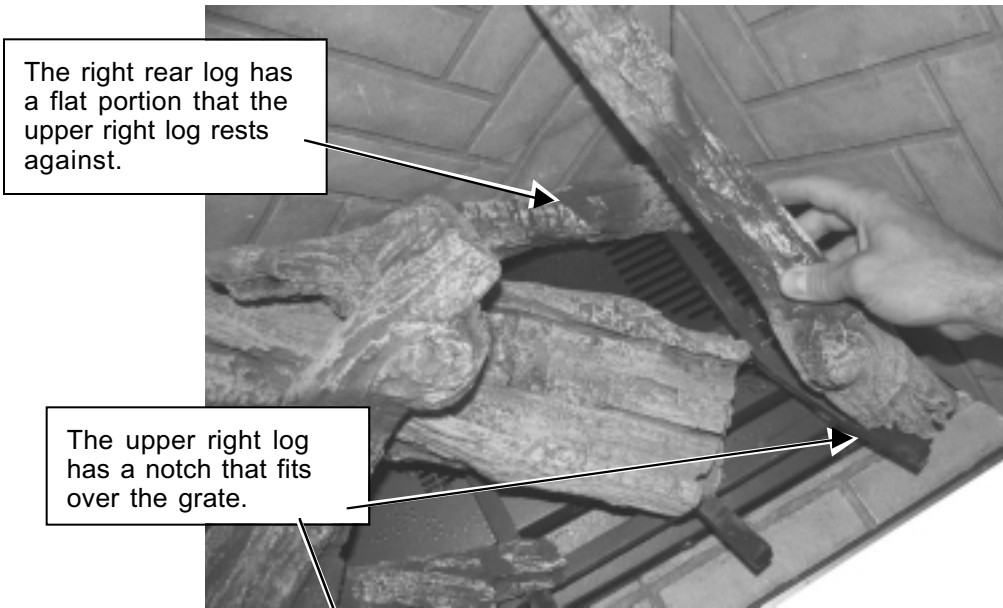

Note how the upper right log is positioned.

Ember Installation

Place the embers along the burner and floor firebacks - make sure they do not cover any burner holes.

Glass Cleaning

The glass may be cleaned with a non-abrasive cleaner. To clean the inside of the glass, simply remove the glass frame, place it on a non-scratching surface, and clean the inside surface.

WARNING: do not operate the fireplace without the glass assembly in place.

Battery Installation

HINT: When the flame height adjustment no longer operates, this is an indication that the battery box batteries are low and require replacement.

See the directions below for battery replacement.

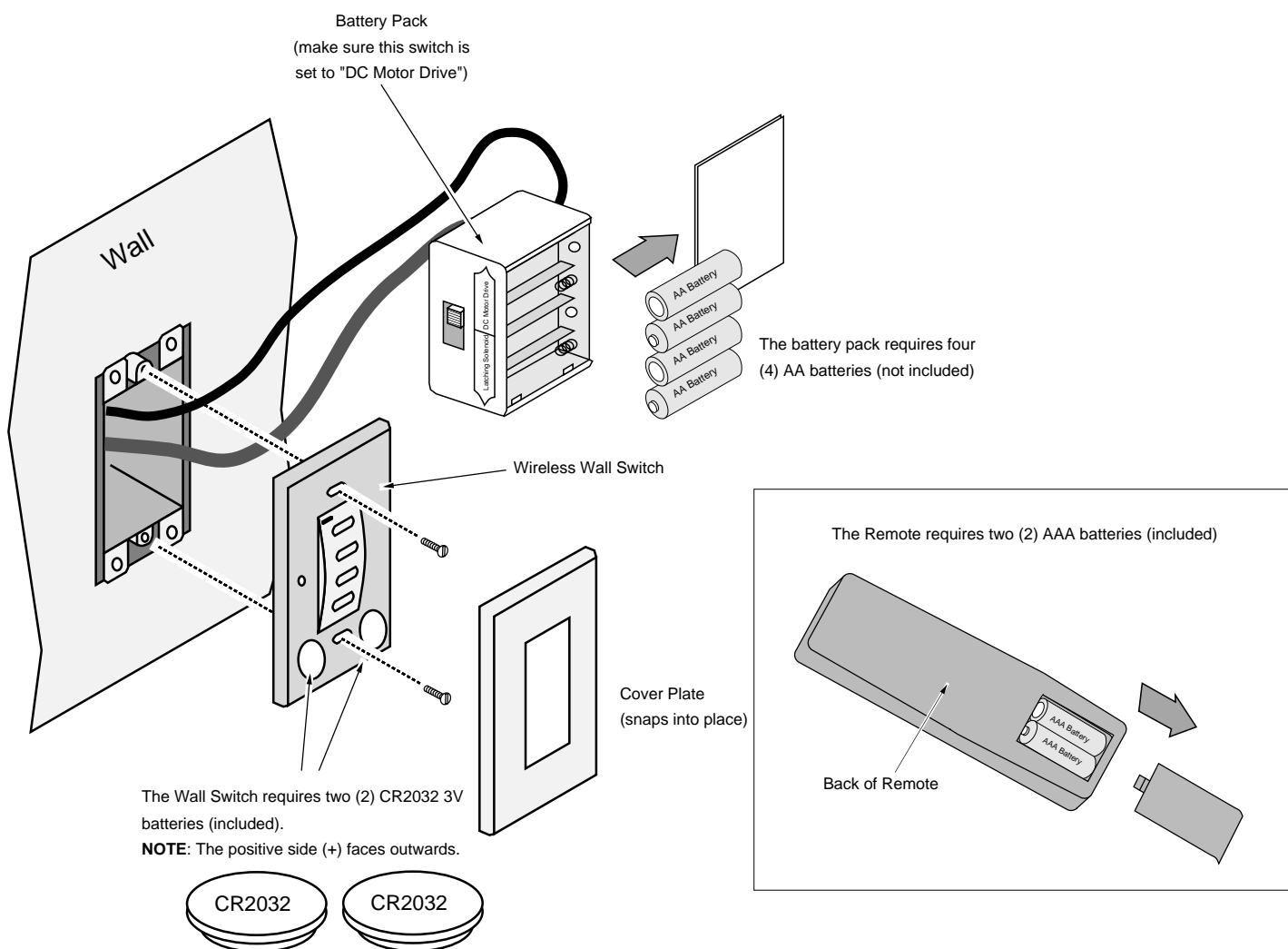

Wiring Diagram

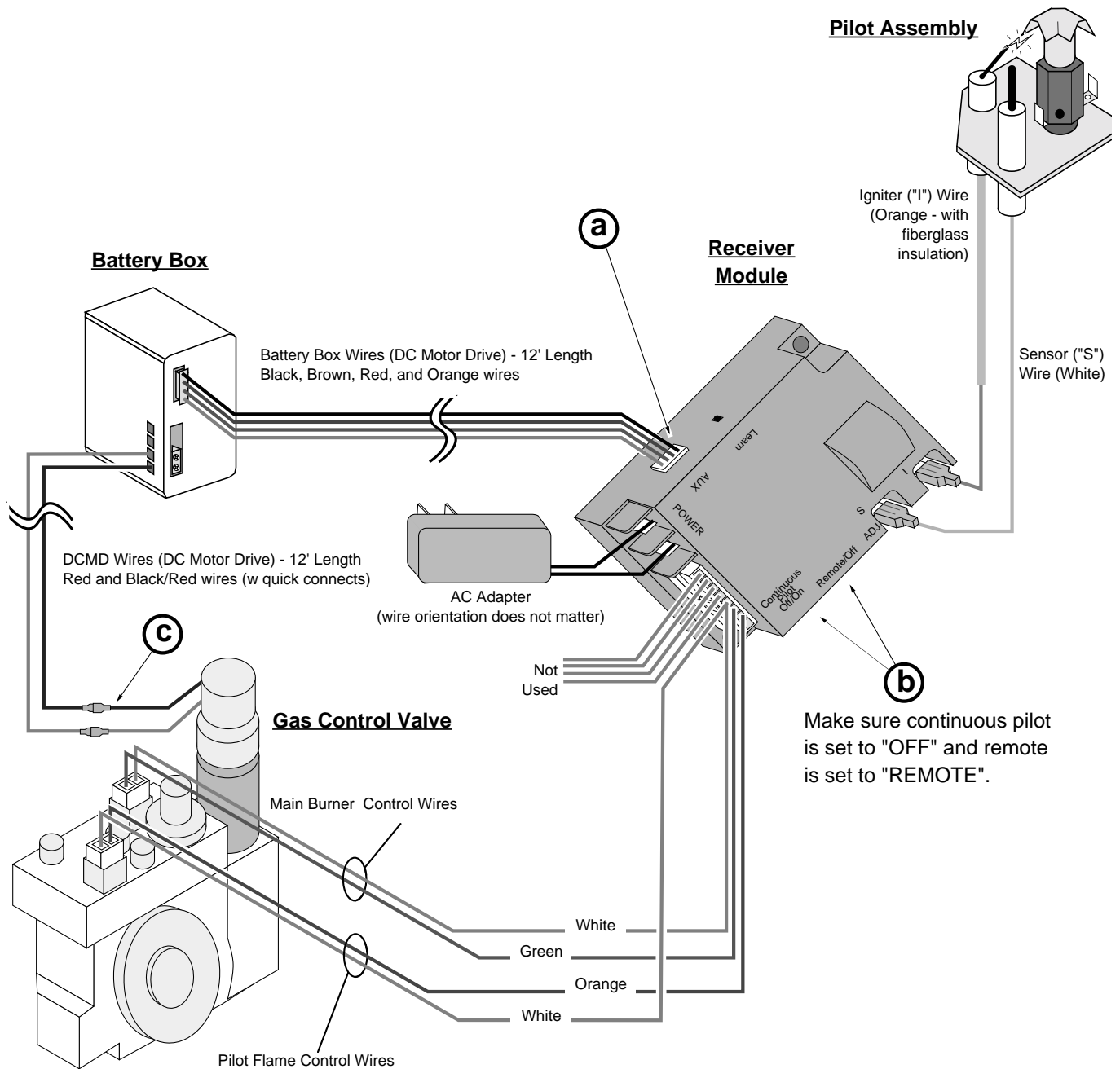

Caution: Label all wires prior to disconnection when servicing controls. Wiring errors can cause improper and dangerous operation.

Replacement Parts List

Caution: Use only Travis Industries replacement parts. Do not use substitute materials.

Warning: Do not operate appliance with the glass front removed, cracked, or broken. Replacement of the glass should be done by a licensed or qualified service person.

To register your TRAVIS INDUSTRIES, INC. 7 Year Warranty, complete the enclosed Warranty card and mail it within **ten (10)** days of the appliance purchase date to: TRAVIS INDUSTRIES, INC., 4800 Harbour Pointe Blvd. SW, Mukilteo, WA 98275. TRAVIS INDUSTRIES, INC. warrants this gas appliance (appliance is defined as the equipment manufactured by Travis Industries, Inc.) to be defect-free in material and workmanship to the original purchaser from the date of purchase as follows:

Check with your dealer in advance for any costs to you when arranging a warranty call.
Mileage or service charges are not covered by this warranty. This charge can vary from store to store.

Years 1 & 2 - COVERAGE: PARTS & LABOR

Burner Assembly:

Burner, Burner Pan, Air Shutter Assembly, Main Burner Orifice, Grate

Firebox Assembly:

Adjustable Air Restrictor, Pressure Relief Mechanisms, Barometric Control Mechanism (for models with Remote Heat Ducts), Glass Attachment Mechanism

Electrical Assembly (within heater structure):

Wiring harness

Gas Control Assembly

Adjustable control valve, wiring and connectors (located within the metal heater structure), thermopile, thermocouple, pilot hood, orifices, pilot gas line, ignitor

Glass

Glass (breakage from thermal shock)

Ceramic Logs

Log Set, Coals, Ember Strip (Steel Fiber)

Accessories

Cast Firebacks, Andirons, Trim

Heat Bypass Assembly

Re-Installation Allowance

In cases where heater must be removed from home for repairs, a partial cost of re-installation is covered (pre-authorization required)

One-Way Freight Allowance

One-way freight allowance on pre-authorized repair done at factory is covered.

Exclusions: Paint, Gasketing

Years 3 THROUGH 5 - COVERAGE: PARTS & LABOR

Firebox Assembly:

Adjustable Air Restrictor, Pressure Relief Mechanisms, Barometric Control Mechanism (for models with Remote Heat Ducts), Glass Attachment Mechanism

One-Way Freight Allowance

One-way freight allowance on pre-authorized repair done at factory is covered.

Exclusions: Paint, Gasketing, Burner Assembly, Electrical Assembly, Gas Control Assembly, Glass, Ceramic Logs, Accessories, Heat Bypass Assembly, Re-Installation Allowance

Years 6 & 7 - COVERAGE: PARTS ONLY

Firebox Assembly:

Adjustable Air Restrictor, Pressure Relief Mechanisms, Barometric Control Mechanism (for models with Remote Heat Ducts), Glass Attachment Mechanism

Exclusions: Paint, Gasketing, Burner Assembly, Electrical Assembly, Gas Control Assembly, Glass, Ceramic Logs, Accessories, Heat Bypass Assembly, Re-Installation Allowance, One-Way Freight Allowance, Labor

CONDITIONS & EXCLUSIONS

- This new gas appliance must be installed by a qualified gas appliance technician. It must be installed, operated, and maintained at all times in accordance with the instructions in the Owner's Manual. Any alteration, willful abuse, accident, neglect, or misuse of the product shall nullify this warranty.
- This warranty is nontransferable, and is made to the ORIGINAL purchaser, provided that the purchase was made through an authorized TRAVIS dealer.
- Discoloration and some minor expansion, contraction, or movement of certain parts and resulting noise, is normal and not a defect and, therefore, not covered under warranty. The installer must ensure the appliance is burning as per the rating tag at the time of installation. Over-firing (operation above the listed BTU rate) of this appliance can cause serious damage and will nullify this warranty.
- The warranty, as outlined within this document, does not apply to the chimney components or other Non-Travis accessories used in conjunction with the installation of this product. If in doubt as to the extent of this warranty, contact your authorized TRAVIS retailer before installation.
- Travis Industries will not be responsible for inadequate performance caused by environmental conditions such as nearby trees, buildings, roof tops, wind, hills or mountains or negative pressure or other influences from mechanical systems such as furnaces, fans, clothes dryers, etc.
- This Warranty is void if:
 - The unit has been operated in atmospheres contaminated by chlorine, fluorine or other damaging chemicals.
 - The unit is subject to submersion in water or prolonged periods of dampness or condensation.
 - Any damage to the unit, combustion chamber, heat exchanger or other components due to water, or weather damage which is the result of, but not limited to, improper chimney/venting installation.
- Exclusions to this 7 Year Warranty include: injury, loss of use, damage, failure to function due to accident, negligence, misuse, improper installation, alteration or adjustment of the manufacturer's settings of components, lack of proper and regular maintenance, damage incurred while the appliance is in transit, alteration, or act of God.
- This 7 Year warranty excludes damage caused by normal wear and tear, such as paint discoloration or chipping, worn or torn gasketing, corroded or cracked logs, embers, etc. Also excluded is damage to the unit caused by abuse, improper installation, modification of the unit, drilling of the orifices, or the use of fuel other than that for which the unit is configured. Units are shipped for natural gas and must be converted to propane using the included conversion kit. Confirm fuel configuration with your installer.
- Damage to gold or nickel surfaces caused by fingerprints, scratches, melted items-, or other external sources left on the gold or nickel from the use of cleaners other than denatured alcohol is not covered in this warranty.
- TRAVIS INDUSTRIES, INC. is free of liability for any damages caused by the appliance, as well as inconvenience expenses and materials. Incidental or consequential damages are not covered by this warranty. In some states, the exclusion of incidental or consequential damage may not apply.
- This warranty does not cover any loss or damage incurred by the use or removal of any component or apparatus to or from the gas appliance without the express written permission of TRAVIS INDUSTRIES, INC. and bearing a TRAVIS INDUSTRIES, INC. label of approval.
- Any statement or representation of TRAVIS products and their performance contained in TRAVIS advertising, packaging literature, or printed material is not part of this 7 year warranty.
- This warranty is automatically voided if the appliance's serial number has been removed or altered in any way. If the appliance is used for commercial purposes, it is excluded from this warranty.
- No dealer, distributor, or similar person has the authority to represent or warrant TRAVIS products beyond the terms contained within this warranty. TRAVIS INDUSTRIES, INC. assumes no liability for such warranties or representations.
- Travis Industries will not cover the cost of the removal or re-installation of hearths, facing, mantels, venting or other components.
- If for any reason any section of this warranty is declared invalid, the balance of the warranty remains in effect and all other clauses shall remain in effect.
- THIS 7 YEAR WARRANTY IS THE ONLY WARRANTY SUPPLIED BY TRAVIS INDUSTRIES, INC., THE MANUFACTURER OF THE APPLIANCE. ALL OTHER WARRANTIES, WHETHER EXPRESS OR IMPLIED, ARE HEREBY EXPRESSLY DISCLAIMED AND PURCHASER'S RECOURSE IS EXPRESSLY LIMITED TO THE WARRANTIES SET FORTH HEREIN.

IF WARRANTY SERVICE IS NEEDED:

- If you discover a problem that you believe is covered by this warranty, you MUST REPORT it to your TRAVIS dealer WITHIN 30 DAYS, giving them proof of purchase, the purchase date, and the model name and serial number.
- Travis Industries has the option of either repairing or replacing the defective component.
- If your dealer is unable to repair your appliance's defect, he may process a warranty claim through TRAVIS INDUSTRIES, INC., including the name of the dealership where you purchased the appliance, a copy of your receipt showing the date of the appliance's purchase, and the serial number on your appliance. At that time, you may be asked to ship your appliance, freight charges prepaid, to TRAVIS INDUSTRIES, INC. TRAVIS INDUSTRIES, INC. at its option, will repair or replace, free of charge, your TRAVIS appliance if it is found to be defective in material or workmanship within the time frame stated within this 7 year warranty. TRAVIS INDUSTRIES, INC. will return your appliance, freight charges (years 1 to 5) prepaid by TRAVIS INDUSTRIES, INC., to your regional distributor, or dealership.
- Check with your dealer in advance for any costs to you when arranging a warranty call. Mileage or service charges are not covered by this warranty. This charge can vary from store to store.

Accessories

The accessories listed below are available at your Travis dealer. To locate a dealer, visit:

www.travisproducts.com

Andirons

These decorative additions attach to the grate inside the firebox and enhance the wood-fire look of your fireplace.



Trim Kit

This decorative upgrade adds a unique touch to the perimeter of the glass

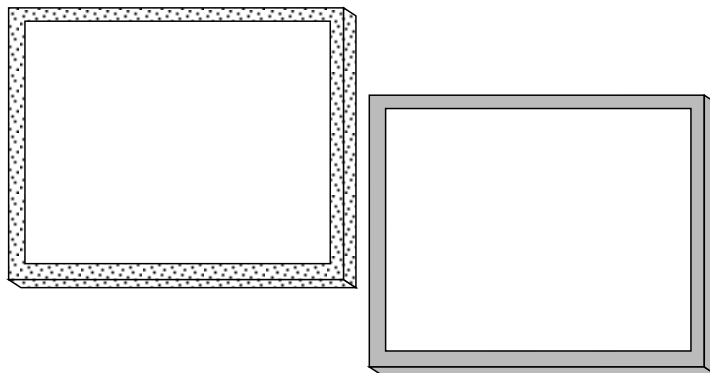

Index

Accessories.....	19	Normal Operating Odors	8
Adjusting the Flame Height.....	8	Odors.....	8
Before You Begin	6	On/Off Operation	
Cleaning.....		Optional Equipment List.....	19
Controls - Location	6	Parts.....	17
Features	3	Pilot - Starting	6
Flame Height Adjustment	8	Replacement Parts List	17
Glass Frame Removal and Installation	10	Safety Precautions.....	4
Gas Input Specifications.....	3	Smells.....	8
Important Information.....	2	Starting the Fireplace for the First Time	8
Installation Warnings.....	2	Warranty	18
Introduction	2	Window Cleaning.....	16
Controls.....	6	Window Removal and Installation	10
Log Set Installation.....	11	Wiring Diagram.....	17
		Yearly Service Procedure.....	9